

SURGICAL KIT  
BT SCREW

**btk**  Implanting Trust,  
Smile Again!

# SURGICAL KIT BT SCREW



KIT OF FIXATION SCREWS,  
PINS AND INSTRUMENTS  
FOR ADVANCED SURGERY

visit [btk.dental](http://btk.dental)

FOLLOW US ON 

# SURGICAL KIT BT SCREW

BTK's BT SCREW kit contains the tools suitable for the correct management of surgical procedure for the fixation of bone grafts, meshes and membranes on the mandible or maxilla. The kit contains a set of fixation screws and pins, with several diameters and length, in order to cover all the surgical needs.

## OVERVIEW

COMPLETE

With drills, screwdrivers, manual and micromotor wrenches, torque wrench, etc.

VERSATILE

Screw fixation by means of handpiece or manual driver

FREE SLOTS

For additional tools and spare parts

SMALL DIMENSION

19.0 x 13.8 x 6.0 cm

AUTO-CLAVABLE

Materials are compliant with sterilization regulations

## PORTFOLIO SCREWS MANUFACTURED IN BIOMEDICAL TITANIUM

### EASY ORGANIZATION

up-to 150 fixation screws e 30 pins

### INNOVATIVE & SAFE

Detachable screw holder with removable cover

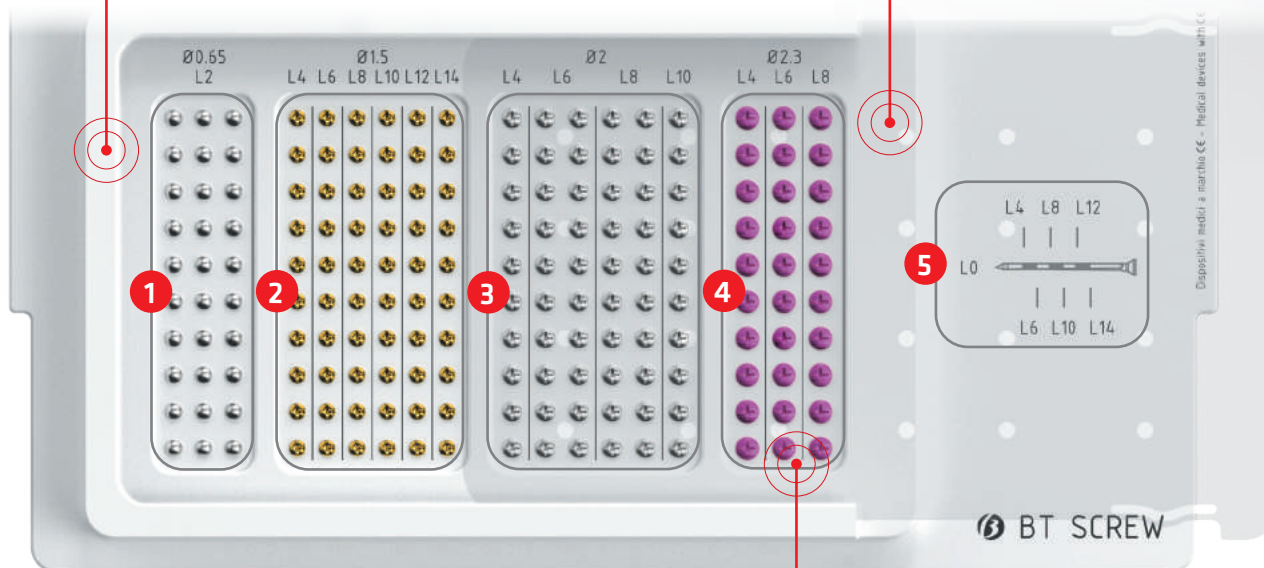

1 PIN Ø 0.65  
L=4



2 SCREW Ø 1.5  
L=4, 6, 8, 10, 12 e 14 mm



3 SCREW Ø 2.0  
L= 4, 6, 8 e 10 mm



4 SCREW Ø 2.3  
L= 4, 6, e 8 mm



### CROSS-HEADED SCREWS

the screw are designed for use with a cross-headed screwdriver

5 1:1 SCALE SKETCH

Ruler for checking the dimensions of the screws and the drill

visit [btk.dental](http://btk.dental)



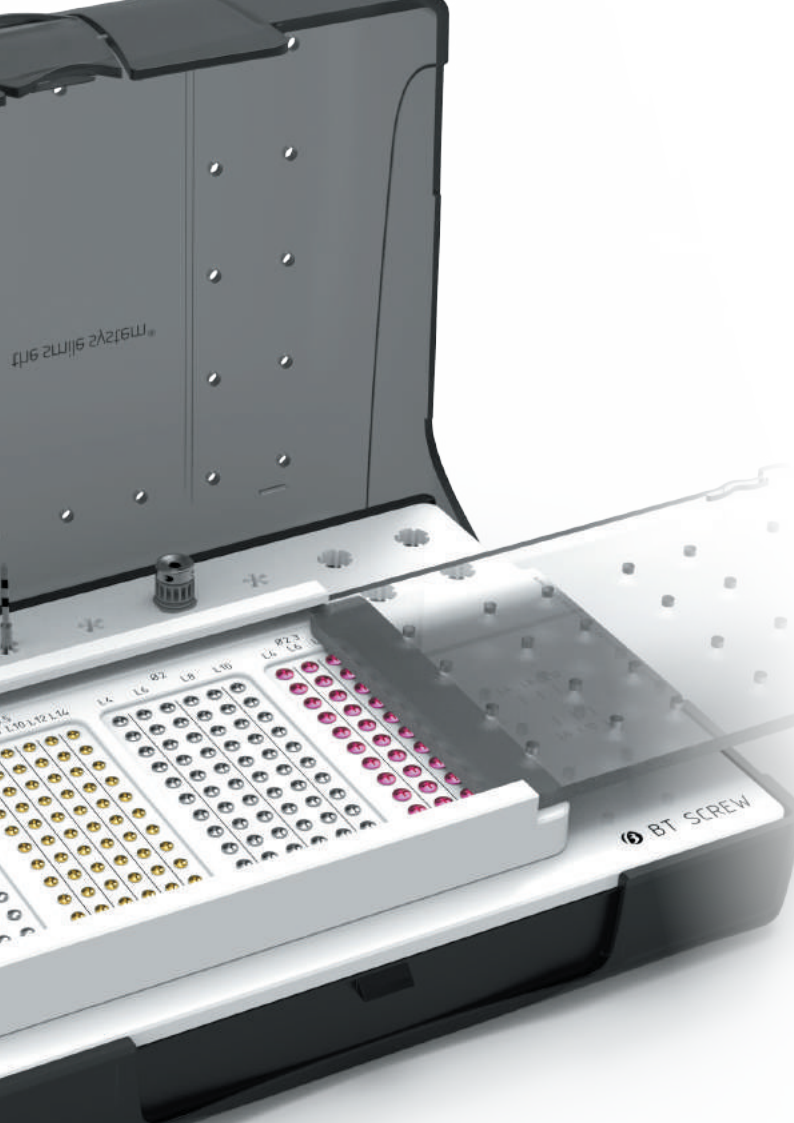

## INSTRUMENTS INCLUDED IN THE KIT

### DRILLING TOOL FOR PINS

	Ø0.5mm L49mm	415HR050
--	--------------	----------



### LANCE DRILLS

	Ø1mm L33.5mm	415HL100
	Ø1mm L29.5mm	415HS100
	Ø1.5mm L29.5mm	415HS150

### INSERTION DEVICE FOR PINS

	L49mm	530HS020
--	-------	----------

### HANDPIECE DRIVER

	CR0.41 L29mm	530HS021
	CR0.41 L49mm	530HL004

### MANUAL SCREWDRIVER

	L140 mm	520MA002
--	---------	----------

### SCREWDRIVER JD

	HEX1.20 L15mm	530JD005
--	---------------	----------

## OPTIONAL INSTRUMENTS

### TORQUE WRENCH JD

	Reversible 90 Ncm	501JD003
--	----------------------	----------

### SCREWDRIVER JD

	HEX0.90 L15mm	530JD012
--	---------------	----------

### DRILL EXTENSION HS

	L28 mm	520HS004
--	--------	----------

### SURGICAL RETRACTOR

	70x16mm / 50x12mm	502MA008
--	-------------------	----------

### ADAPTER CONNECTION





















	ISO/HEX3.10-JD L10mm	530JD033
--	----------------------	----------



**MANUAL SCREWDRIVER**  
compatible with tools  
with iso connection

## SCREW PORTFOLIO

### PIN AND CORTICAL SCREW AVAILABLE WITH THE KIT BT SCREW

	Ø0.65mm L2mm	10 pcs	167NA65A.10		Ø2mm L4mm CR0.41	5 pcs	167NA20C.05
	Ø1.2mm L4mm CR0.41	5 pcs	167NA12C.05*		Ø2mm L6mm CR0.41	5 pcs	167NA20G.05
	Ø1.2mm L6mm CR0.41	5 pcs	167NA12G.05*		Ø2mm L8mm CR0.41	5 pcs	167NA20J.05
	Ø1.2mm L8mm CR0.41	5 pcs	167NA12J.05*		Ø2mm L10mm CR0.41	5 pcs	167NA20L.05
	Ø1.2mm L10mm CR0.41	5 pcs	167NA12L.05*		Ø2.3mm L4mm CR0.41	5 pcs	167NA23C.05
	Ø1.2mm L12mm CR0.41	5 pcs	167NA12N.05*		Ø2.3mm L6mm CR0.41	5 pcs	167NA23G.05
	Ø1.2mm L14mm CR0.41	5 pcs	167NA12Q.05*		Ø2.3mm L8mm CR0.41	5 pcs	167NA23J.05
	Ø1.5mm L4mm CR0.41	5 pcs	167NA15C.05				
	Ø1.5mm L6mm CR0.41	5 pcs	167NA15G.05				
	Ø1.5mm L8mm CR0.41	5 pcs	167NA15J.05				
	Ø1.5mm L10mm CR0.41	5 pcs	167NA15L.05				
	Ø1.5mm L12mm CR0.41	5 pcs	167NA15N.05				
	Ø1.5mm L14mm CR0.41	5 pcs	167NA15Q.05				

### NOTE

The pins and fixation screws can be ordered separately in packs of 10pcs and 5pcs respectively (the codes are indicated in the table). The fixation screws are also available, upon request, with surface treated by double etching (codes 168NA ..). For more information, contact your BTK'S Distributor.

\* SCREWS NOT INCLUDED IN THE KIT

# SURGICAL PROCEDURE

DRILLS	PIN / SCREW				
	PIN Ø0.65mm	SCREW Ø1.2mm	SCREW Ø1.5mm	SCREW Ø2mm	SCREW Ø2.3mm
Drilling Tool for Pins Ø0.5 L49mm 415HR050	●				
Lance Drill HR Ø1 L33.5mm 415HL100		●	●		
Lance Drill HS Ø1 L29.5mm 415HS100		●	●		
Lance Drill HS Ø1.5 L29.5mm 415HS150				●	●

In order to achieve a successful fixation of the screw within the bone site, a precise and low-trauma surgical technique is required. BTK suggests to prepare the fixation site using the adequate lance drills combined with a proper drilling process (suggested speed 800 rpm). The direction and depth of the drill preparation must be carefully and clinically evaluated. Following the procedure indicated in the table, the screws are inserted at a maximum value of 25Ncm.

In cases of insertion of L4mm screws or insertion in D3 and D4 density bone, the surgeon must take care during the final tightening, because there is a risk that, due to the few threads engaged or the inconsistent bone density, the site will be damaged. For this reason, the screw must be tightened until the contact point between the under-head of the screw and the medical device, without an over tightening of the screw. The indicated lengths of the screws correspond to the threaded part (excluding the head size which is 0.9mm).

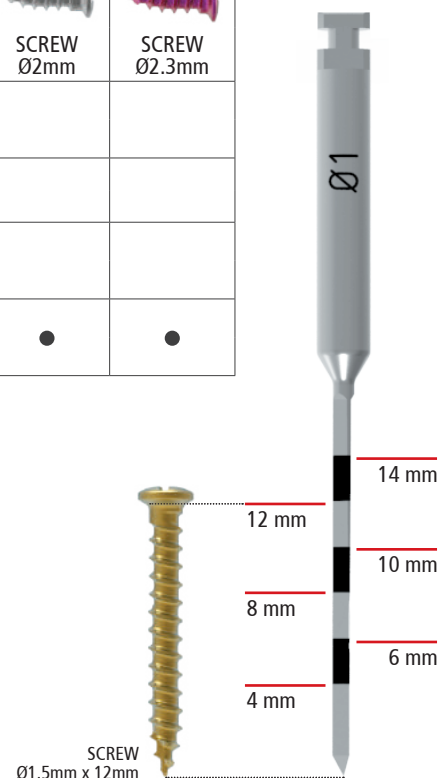

## INDICATIONS OF USE: APPLICATION EXAMPLES

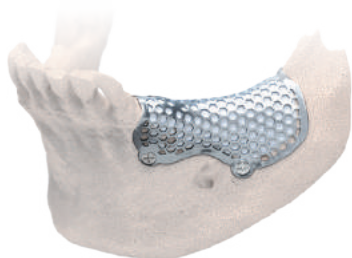

### GUIDED BONE REGENERATION (GBR) 3D-MESH

The 3D-MESH bone regeneration mesh is an implantable medical device made to measure for each single patient. It is made of biomedical titanium using the innovative Selective Laser Melting technology. 3D-MESH is developed based on the dentist's plan and it is made in compliance with the specific treatment needs of each individual patient.



### 3D-BONE CUSTOMIZED BONE GRAFTS

The "3D-BONE" service offers clinicians an innovative, synthetic bone grafts made to measure, modelled with utmost precision based on the patient's bone defect. Based on the patient's CBCT, the bone graft is produced using CAD-CAM technology. It can be used for small and medium sized bone reconstructions and to prepare the site for receiving one or several dental implants needed to replace missing teeth.



### LUXTA-3D SUB-PERIOSTEAL IMPLANTS

The LUXTA-3D service allows to solve cases of extreme atrophy of the upper and lower jaw when the bone is not sufficient for conventional endosseous titanium implants. The juxta-osseous implant is designed based on the patient's examination, it is customized following the patient's anatomical features and prosthetic needs and it is made of biocompatible, certified titanium.



### IMPLANTABLE DEVICES FOR CRANIO-MAXILLO-FACIAL SURGERY

BTK can produce implantable medical devices for patients who need advanced surgical rehabilitation. These devices are developed following the request of practitioner, based on the examination and needs of individual patients. They are made of biomedical titanium and are prepared by means of a verified and traced production process.



## Complete Kit BT-SCREW

(with tools and full screw-rack)

Cod. 667NA001

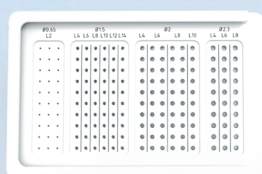

## Empty Screw-Rack

Cod. 667NA002

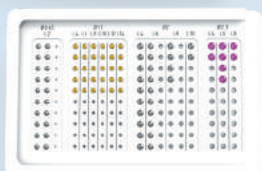

## Compact Screw-Rack

Cod. 667NA003

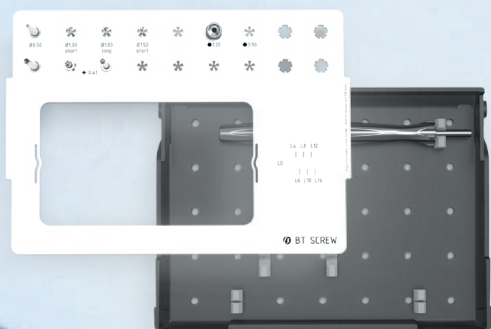

## Kit BT-SCREW

without screw-rack, with tools

Cod. 667NA004



## SURGICAL KIT BT SCREW



### BTK PERSONAL TUTOR

A program for individual case planning and execution supported by experienced professionals in order to leverage know-how and maximize clinical experience with the aim to achieve sustainable high patient satisfaction rates.

**BTK is always at your disposal for any request for further follow-up or information, promoting periodic and ad-hoc training course.**

### CERTIFIED QUALITY SYSTEM

BIOTEC is certified UNI EN ISO 9001  
and UNI EN ISO 13485.



CE marked product, in accordance with Directive 93/42/EEC and subsequent modifications and additions.

### MADE IN ITALY USED GLOBALLY



We constantly ensure that the quality of our products and services meet the high expectations of our customers and their patients.

Specialized professionals are taking care to offer comprehensive solutions in applied research, engineering, education and related activities.



BIOTEC S.R.L. VIA INDUSTRIA, 53  
36031 POVOLARO DI DUEVILLE (VI) - ITALY  
TEL: +39 0444 361251 - FAX: +39 0444 361249  
mail: [info@btk.dental](mailto:info@btk.dental)

visit [btk.dental](http://btk.dental)

COD. 06200123 REV. 4 - 13.5.2021  
ALL IMAGES ARE FOR ILLUSTRATIVE PURPOSE. The informations may contain typographical imprecisions.  
Biotec srl reserves the right to make changes, corrections and / or improvements to the document without notice. The content is updated at the date of publication.  
It is customer's responsibility to check the latest update available, by contacting Biotec or visiting the website [www.btk.dental](http://www.btk.dental).

FOLLOW US ON

